



BELLEVUE
ARCHITECTURAL

Flush & Sliding Door Pulls & Door Stops

Edge Pulls, Flush Pulls, Privacy Flush Pulls For Timber,
Glass & Aluminium Swing & Sliding Doors
Door Stops, Wall & Floor Mounted
From Italy, Spain, Austria & Japan



+61 3 9571 5666



www.bellevuearch.com.au



info@bellevuearch.com.au



[instagram.com/
bellevue_architectural](https://www.instagram.com/bellevue_architectural)



Beautiful right down to the smallest detail; a sliding door that disappears completely into the wall.

A type of sliding door installed so as to allow the end of the door to be concealed. Even when the sliding door has been opened completely, it may be grasped and pulled out. Because it is unnecessary to leave the handle part of the sliding door exposed, the neat impression of a completely flat door opening is obtained, ensuring an even wider opening. The fixing screws are behind an accessory plate providing a seamless finish. This is suitable for making high-grade details in spaces.

T2940 - Sliding Door Flush End Pull

Product Index

Privacy Flush Pulls for Sliding Doors

Privacy Flush Pulls

Pg. 6 - 11

General Flush Pulls for Sliding Doors

Passage Models

Pg. 12 - 18

Edge Pulls for Sliding Doors

Built in Edge Mounted Flush Pulls

Pg. 19 - 28

Concealed Flush Pulls for Swing & Sliding Doors

Fully Concealed Flush Pulls

Pg. 29 - 34

Sly Stainless Steel Sliding Flush & End Pulls

Face Mounted Designer Flush Pulls

Pg. 35 - 45

Door Stops

Wall mounted & floor mounted

Pg. 44 - 47

BI4250 - see Pg. 24



BI3250 - see Pg. 22



PRE154 | Privacy Flush Pull

Elmes of Japan

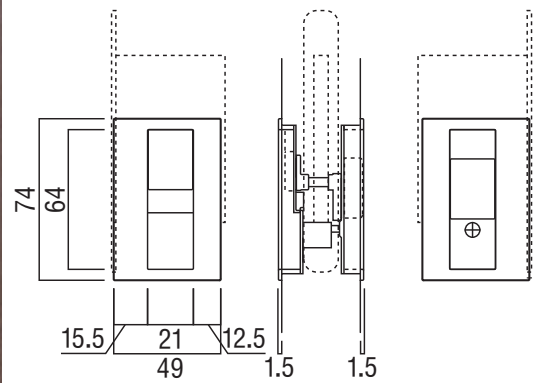

Matching Flush Pull on Pg. 18

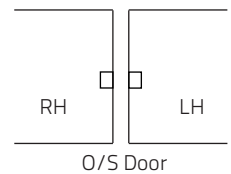

Door Suitability:

Door Thickness: 40 - 47mm

Available Finishes:

CR = Polished Chrome
MB = Matt Black

Specification Codes:

PRE154LH - Finish
PRE154RH - Finish
Includes sliding door latch

AUK122 | Privacy Flush Pull Elmes of Japan

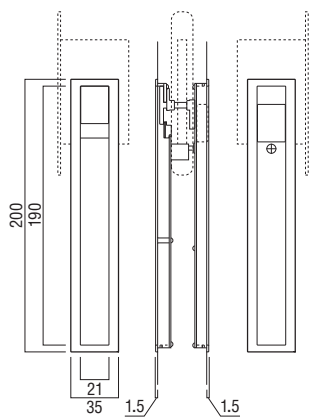

Matching Flush Pull on Pg. 10

Door Suitability:

Door Thickness: 36-40mm

Available Finishes:

CR = Polished Chrome

SN = Satin Nickel

AN = Anthracite

Specification Codes:

AUK122 - Finish

Includes sliding door latch



K14250L | Privacy Flush Pull

Didheya of Spain

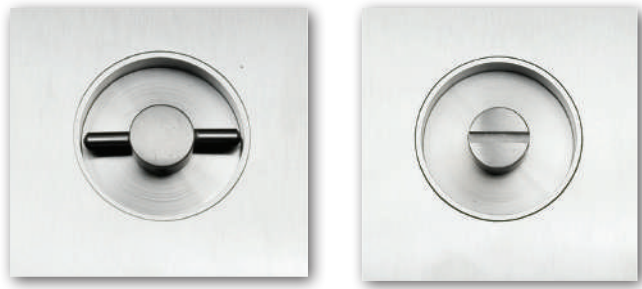

Door Suitability:

Door Thickness: 32mm +
timber doors only

Available Finishes:

SS satin stainless steel
PS polished stainless steel (face only)
PC powder coat

Specification Codes:

K14250L - Finish
Includes sliding door latch

Matching Flush Pull on Pg. 12

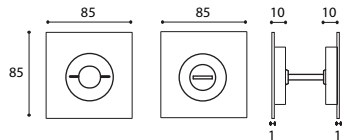

D127L | Giotto Q Privacy Flush Pull

Olivari of Italy

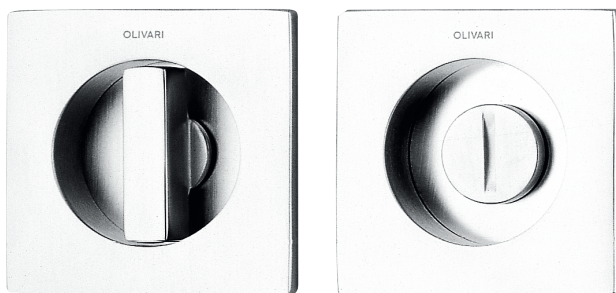

Door Suitability:

Door Thickness: 40mm +
timber & aluminium doors

Available Finishes:

CR, SC
IB, IS, IBN, ISN, ISB
IA, ISC, ISBRZ
PBU, BRZ

Specification Codes:

D127L - Finish
Includes sliding door latch

Matching Flush Pull on Pg. 12

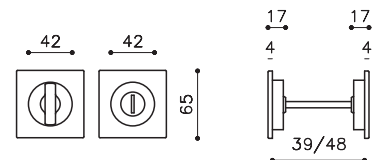

Suitable for timber & aluminium doors

D128L | Giotto Q Privacy Flush Pull

Olivari of Italy

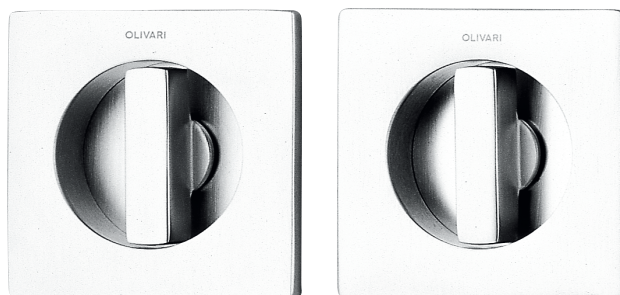

Door Suitability:

Door Thickness: 40mm +
timber & aluminium doors

Available Finishes:

CR, SC
IB, IS, IBN, ISN, ISB
IA, ISC, ISBRZ
PBU, BRZ

Specification Codes:

D128L - Finish
Includes sliding door latch

Matching Flush Pull on Pg. 12

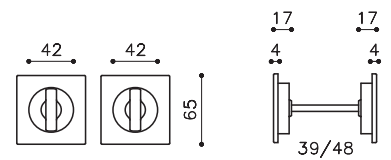

Suitable for timber & aluminium doors

K13250L | Privacy Flush Pull

Didheya of Spain

Door Suitability:

Door Thickness: 32mm +
timber doors only

Available Finishes:

SS satin stainless steel
PS polished stainless steel (face only)
PC powder coat

Specification Codes:

K13250L - Finish
Includes sliding door latch

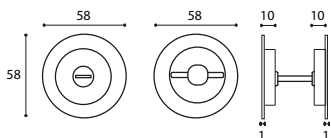

D132L | Dante Privacy Flush Pull

Olivari of Italy

Door Suitability:

Door Thickness: 40mm +
timber & aluminium doors

Available Finishes:

CR, SC
IB, IS, IBN, ISN, ISB
IA, ISC, ISBRZ
PBU, BRZ

Specification Codes:

D132L - Finish
Includes sliding door latch

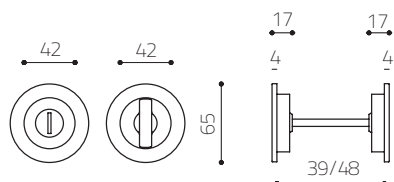

Matching Flush Pull on Pg. 12

Suitable for timber & aluminium doors

D133L | Dante Privacy Flush Pull

Olivari of Italy

Door Suitability:

Door Thickness: 40mm +
timber & aluminium doors

Available Finishes:

CR, SC
IB, IS, IBN, ISN, ISB
IA, ISC, ISBRZ
PBU, BRZ

Specification Codes:

D133L - Finish
Includes sliding door latch

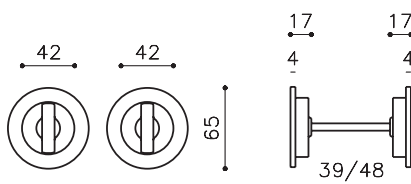
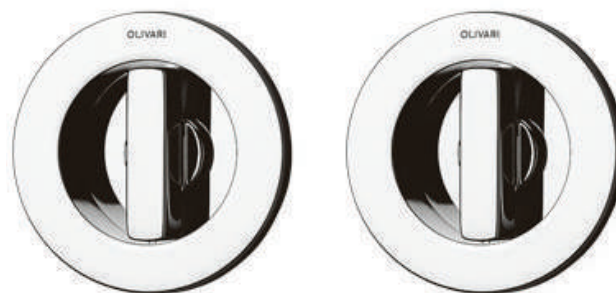

Matching Flush Pull on Pg. 12

Suitable for timber & aluminium doors

K4500L | Privacy Sliding Latch

Didheya of Spain

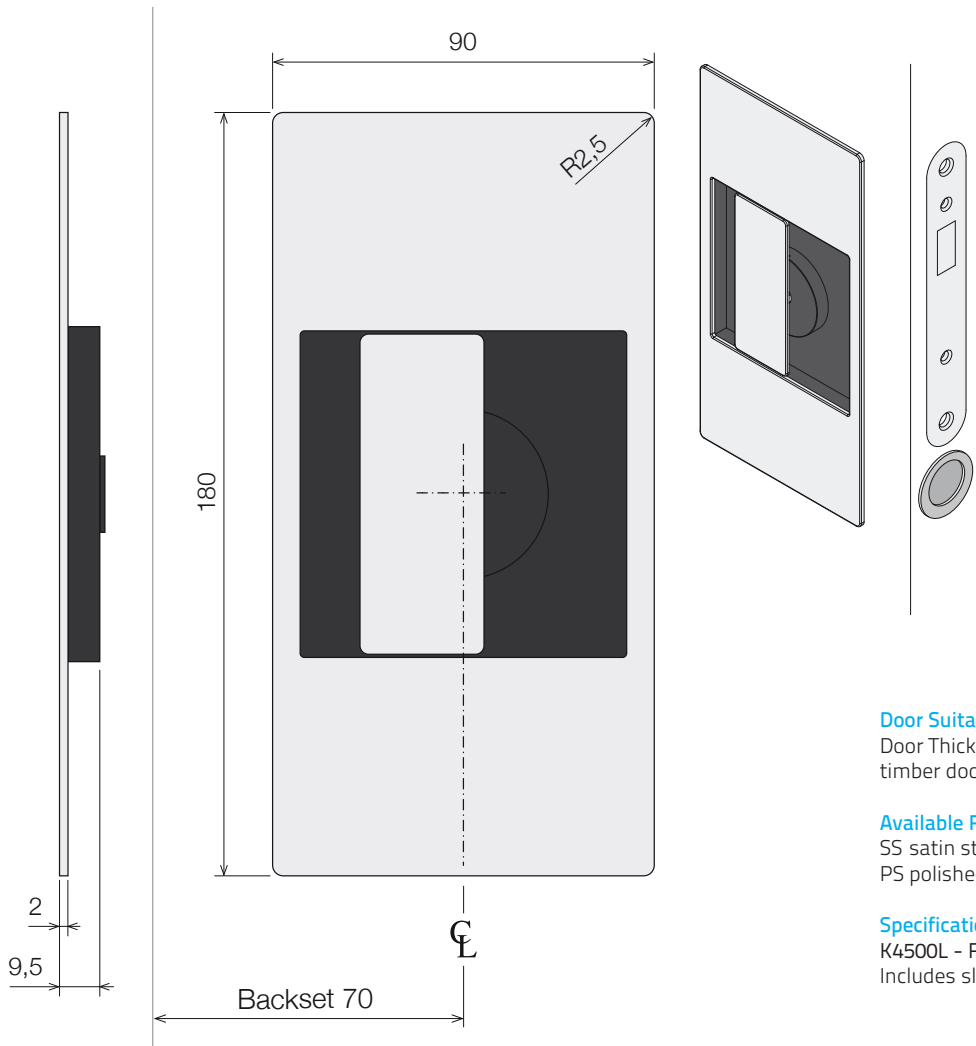

Door Suitability:

Door Thickness: 34mm +
timber doors only

Available Finishes:

SS satin stainless steel
PS polished stainless steel (face only)

Specification Codes:

K4500L - Finish
Includes sliding door latch





K4500 Privacy Sliding Latch

ATH120 Flush Pull Elmes of Japan



Door Suitability:

Door Thickness: 30mm +
timber doors only

Available Finishes:

CR = Polished Chrome
SN = Satin Nickel
AN = Anthracite

Specification Codes

ATH120 - Finish

see matching privacy flush pull
on page 5

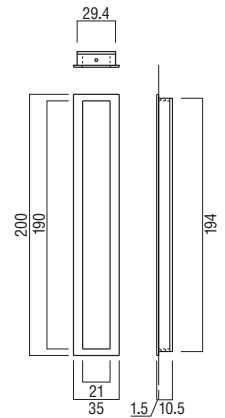

ATH403 Flush Pull Elmes of Japan

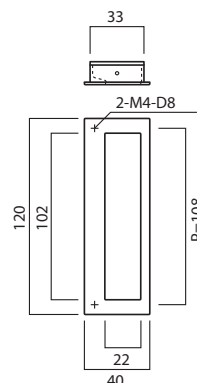

Door Suitability:

Door Thickness: 30mm +
timber doors only

Available Finishes:

CR = Polished Chrome
SN = Satin Nickel
AN = Anthracite

Specification Codes

ATH403 - Finish

UT1149 Long Flush Pull

Elmes of Japan

Made by Elmes of Japan, these new sleek, long sliding door flush pulls offer a sophisticated, sleek look and feel.

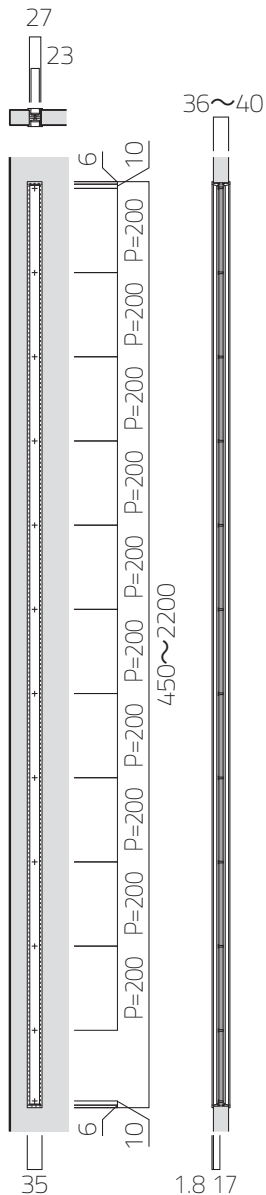

Door Suitability:

Door Thickness: 36-40mm

Available Finishes:

SI = Anodised Silver
 SN = Anodised Stainless Steel
 MB = Anodised Matt Black

Specification Codes:

UT1149A - Finish - 2200mm
 UT1149B - Finish - 1200mm
 UT1149C - Finish - 600mm
 UT1149D - Finish - 450mm



D129 | Giotto Q Flush Pull

Olivari of Italy

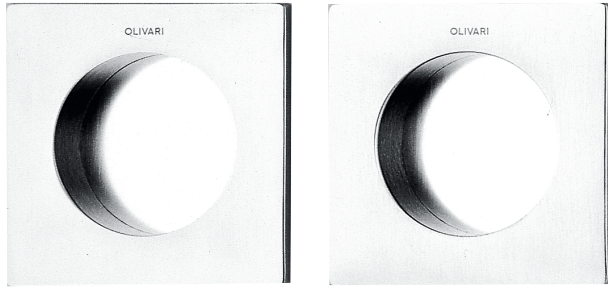

Door Suitability:
timber & aluminium doors

Available Finishes:
CR, SC
IB, IS, IBN, ISN, ISB
IA, ISC, ISBRZ
PBU, BRZ

Specification Codes:
D129 - Finish

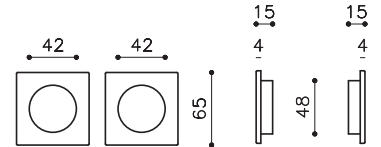

Suitable for timber & aluminium doors

Matching Privacy on Pg. 6

D134 | Dante Flush Pull

Olivari of Italy

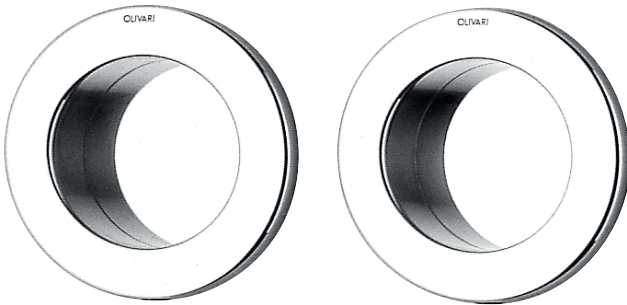

Door Suitability:
timber & aluminium doors

Available Finishes:
CR, SC
IB, IS, IBN, ISN, ISB
IA, ISC, ISBRZ
PBU, BRZ

Specification Codes:
D134 - Finish

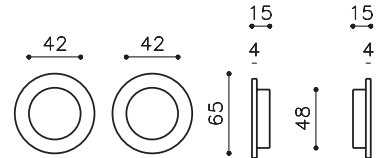

Suitable for timber & aluminium doors

Matching Privacy on Pg. 7

D126 | Sliding Door Finger Pull

Olivari of Italy



Door Suitability:
timber & aluminium doors

Available Finishes:
CR, SC
IB, IS, IBN, ISN, ISB
IA, ISC, ISBRZ
PBU, EMB, BRZ, PC

Specification Codes:
D126 - Finish



Suitable for timber & aluminium doors

D111 | Siro Flush Pull

Olivari of Italy

Door Suitability:
timber & aluminium doors

Available Finishes:
CR, SC
IB, IS, IBN, ISN, ISB
IA, ISC, ISBRZ
PBU

Specification Codes:
D111 - Finish

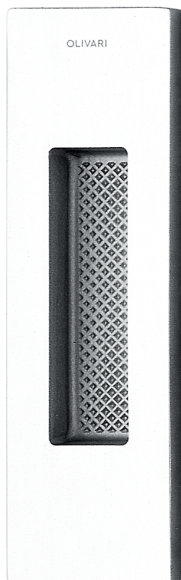
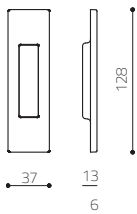

Suitable for timber & aluminium doors

D109 | Vico Flush Pull

Olivari of Italy

Door Suitability:
timber & aluminium doors

Available Finishes:
CR, SC
IB, IS, IBN, ISN, ISB
IA, ISC, ISBRZ
PBU

Specification Codes:
D109 - Finish

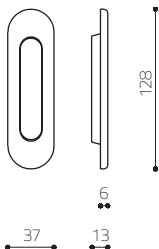

Suitable for timber & aluminium doors

D509 | Nemi Flush Pull

Olivari of Italy

Door Suitability:
timber & aluminium doors

Available Finishes:
BL, WH (nylon)

Specification Codes:
D509 - Finish

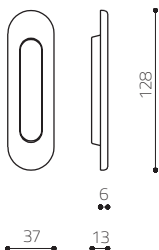

S2155 | Flush Pull

Siro of Austria



Door Suitability:
timber doors

Available Finishes:
CR, SN

Specification Codes:
S2155 - Finish

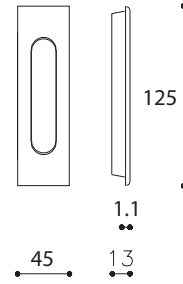

TW02 | Flush Pull

Bellevue



Door Suitability:
timber doors

Available Finishes:
SS

Specification Codes:
TW02SS

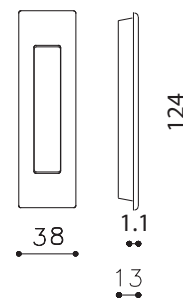

S2291 | Flush Pull

Siro of Austria



A

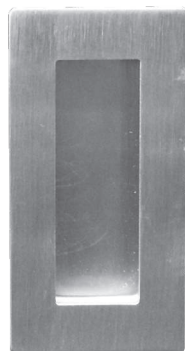

B

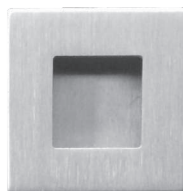

C

Door Suitability:
timber doors

Available Finishes:
SS

Specification Codes:
S2291ASS (L150)
S2291BSS (L102)
S2291CSS (50 x 50mm)

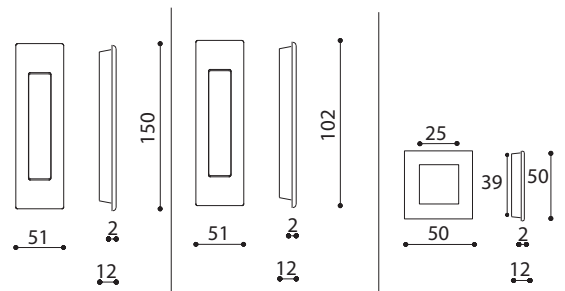

TW01 | Flush Pull

Bellevue

Door Suitability:
timber doors

Available Finishes:
SS

Specification Codes:
TW01SS

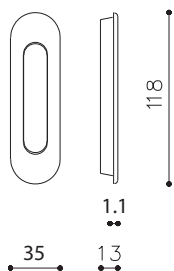

S2293 | Flush Pull

Siro of Austria

Door Suitability:
timber doors

Available Finishes:
SS

Specification Codes:
S2293SS

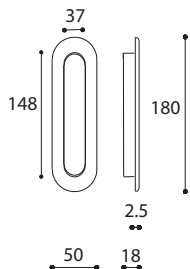

S2294 | Flush Pull

Siro of Austria

Door Suitability:
timber doors

Available Finishes:
SS

Specification Codes:
S2294SS

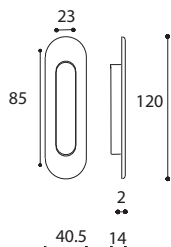

T203 & S2151 | Flush Pull

Elmes of Japan and Siro of Austria



T203



S2155

Door Suitability:

timber doors

Dimensions:

T203 - 90mm Diameter, 14mm depth
S2155 - 90mm Diameter, 19mm depth

Available Finishes:

T203 - SS, PSS
S2151 - CR, SN

Specification Codes:

T203 - Finish (visible fixings on 1 side)
S2151 - Finish

S2292 | Flush Pull

Siro of Austria



Door Suitability:

timber doors

Dimensions:

S2292A - 70mm Diameter, 2 & 15mm depth
S2292B - 50mm Diameter, 2 & 13mm depth

Available Finishes:

S2292A - SS, PSS (face only)
S2292B - SS, PSS (face only)

Specification Codes:

S2292A - Finish
S2292B - Finish

60595 | Flush Pull

Omporo of Italy

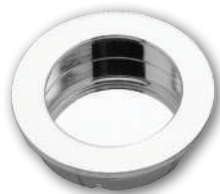

Door Suitability:

timber doors

Dimensions:

60595A - 50mm Diameter, 12mm depth
60595B - 40mm Diameter, 12mm depth

Available Finishes:

CR, SN, PB

Specification Codes:

60595A - Finish
60595B - Finish

T2940 / T2941

Edge Pulls

Elmes of Japan

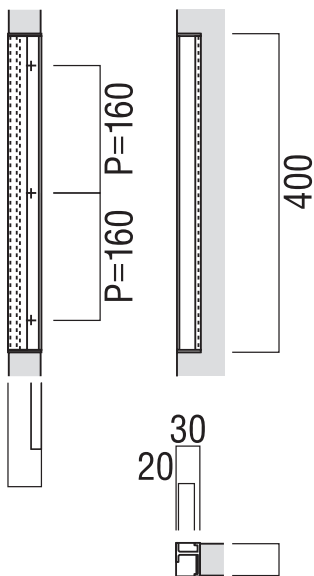

Door Suitability:
timber doors 40-42mm (T2940)
timber doors 36-40mm (T2941)

Dimensions:
400mm length

Available Finishes:
CR - Polished Chrome
BRZ - Dark Bronze

Specification Codes:
T2940 - Finish
T2941 - Finish



ATH404 | Edge Flush Pulls

Elmes of Japan

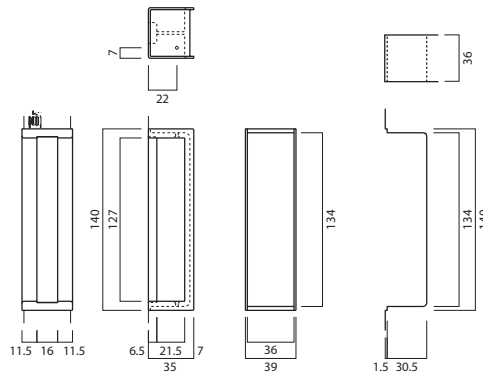

Door Suitability:
timber doors 36mm thick

Dimensions:
140 x 35 x 39mm

Available Finishes:
CR - Polished Chrome
SN = Satin Nickel
AN = Anthracite

Specification Codes:
ATH404 - Finish

PRE150 | Edge Flush Pulls

Elmes of Japan

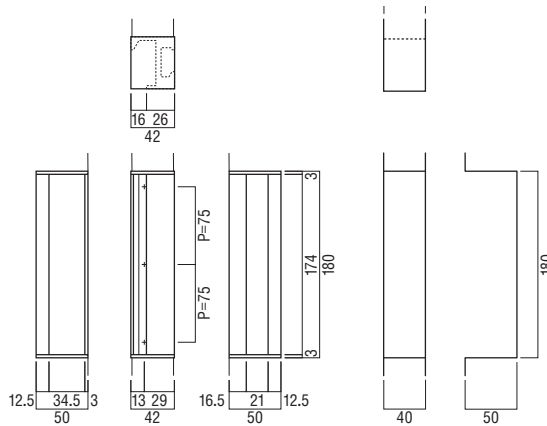

Door Suitability:
timber doors 40mm thick

Dimensions:
180 x 50 x 42mm

Available Finishes:
CR - Polished Chrome
MB = matt Black

Specification Codes:
PRE150 - Finish

see matching privacy flush pull on page 4

PRE151 | Edge Flush Pulls - Ideal for Cupboards Sliding Doors

Elmes of Japan

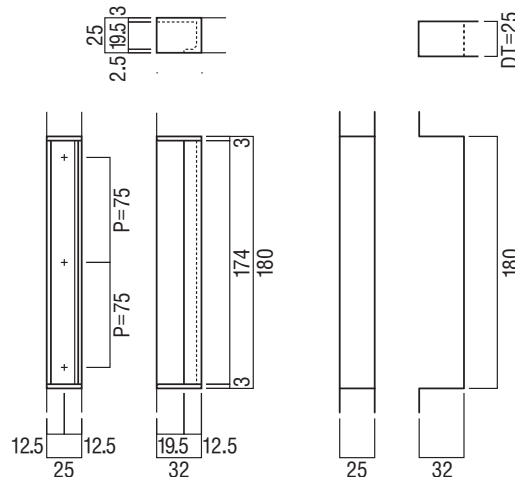

Door Suitability:
timber doors 25mm thick

Dimensions:
180 x 25 x 32

Available Finishes:
CR - Polished Chrome
MB = matt Black

Specification Codes:
PRE151 - Finish

Edge: Edge pulls by Didheya of Spain



Six millimeters thick and in multiple designs. The Edge range from Didheya of Spain is innovative, simple, practical and easy to install. Designed for sliding timber or glass doors in constant use, the Edge range is clean and visually different and appealing.

This is a clear example of pragmatism resolved in a Stainless Steel AISI 304 thick element.

Didheya of Spain by Bellevue



Suitable for 10, 12, 32, 38, 40mm thick glass and timber doors. Custom sizes available

BI3250

Didheya of Spain

code.	A	B	
-------	---	---	---

BI3250A	10	14	1
BI3250B	12	16	1
BI3250C	32	39	1
BI3250D	38	44	1
BI3250E	40	49	1
BI3250F	Custom Size (X, Y, Z)		

SS - STAINLESS STEEL AISI 304
BLK - Matt Balck

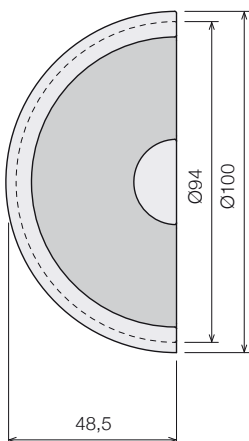
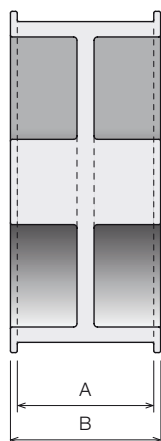

Available Finishes:
SS
BZ



Suitable for 10, 12, 32mm thick glass and timber doors. Custom sizes available

BI5250
Didheya of Spain

code.	A	
BI5250A	10	1
BI5250B	12	1
BI5250C	32	1
BI5250D	40	1
BI5250E	50	1

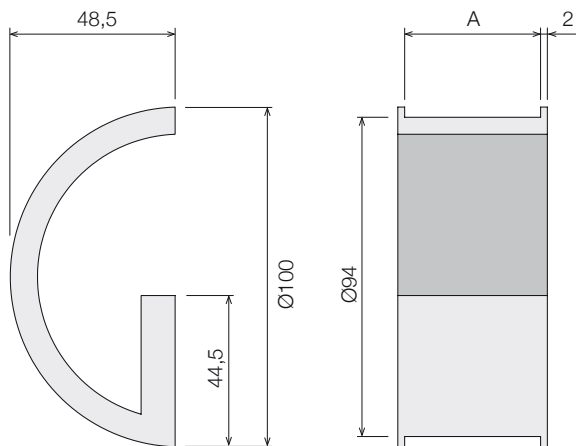

STAINLESS STEEL AISI 304



Door Fully Recessed

BI4250
Didheya of Spain

code. x 

BI4250A	10	1
BI4250B	12	1
BI4250C	32	1
BI4250D	38	1
BI4250E	40	1

BI4250F Custom Size X, Y, Z

SS - STAINLESS STEEL AISI 304
BLK - Matt Black

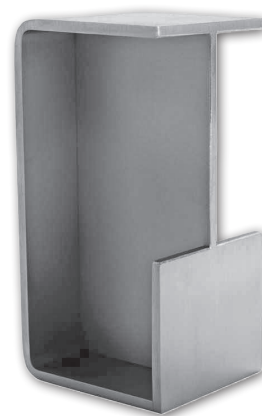
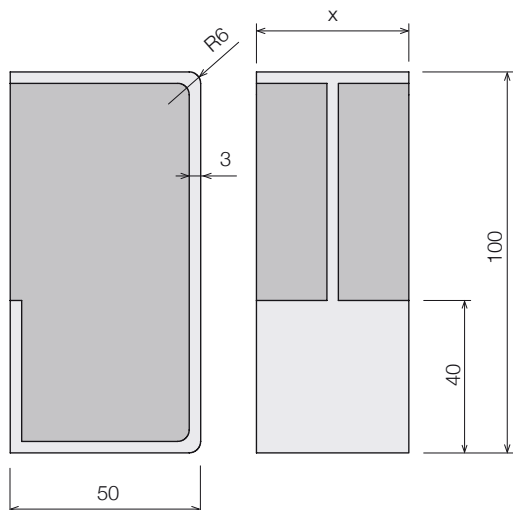

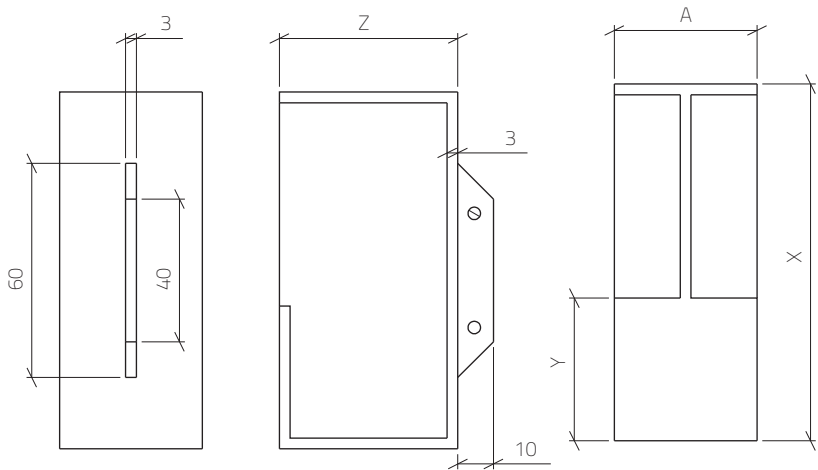

BI4254XX
Didheya of Spain

code.	X	A	Z	Y	
BI42541A	100	10	50	40	1
BI42541B	100	35	50	40	1
BI42541C	100	38	50	40	1
BI42541D	100	40	50	40	1
BI42542A	200	10	85	110	1
BI42542B	200	35	85	110	1
BI42542C	200	38	85	110	1
BI42542D	200	40	85	110	1
BI42543A	300	10	85	210	1
BI42543B	300	35	85	210	1
BI42543C	300	38	85	210	1
BI42543D	300	40	85	210	1

code.	X	A	Z	Y	
BI42545A	500	10	85	410	1
BI42545B	500	35	85	410	1
BI42545C	500	38	85	410	1
BI42545D	500	40	85	410	1
BI42546X	Custom Size X, A, Z, Y 1				

STAINLESS STEEL AISI 304



BI4257
Didheya of Spain

code. A 

BI4257A	35	1
BI4257B	40	1
BI4257C	44.5	1

BI4250D Custom Size X, Y, Z

STAINLESS STEEL AISI 304

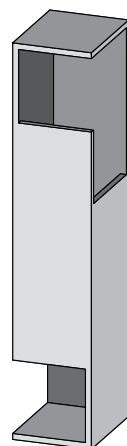
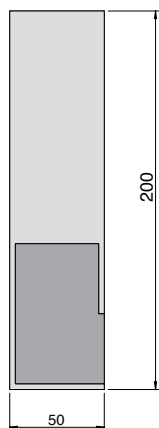



BI4251
Didheya of Spain

code.	X	
BI4251A	35	1
BI4251B	38	1
BI4251C	40	1
BI4251D	45	1
BI4251E	50	1
BI4251F	Custom Size	

STAINLESS STEEL AISI 304

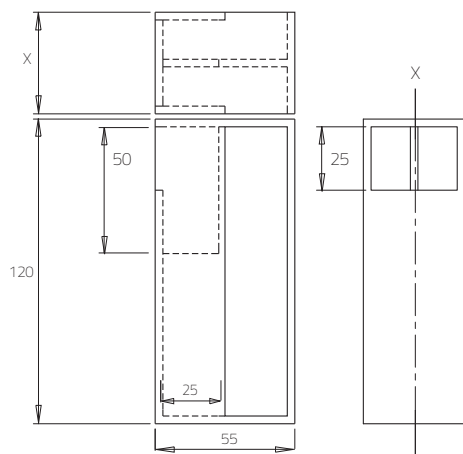

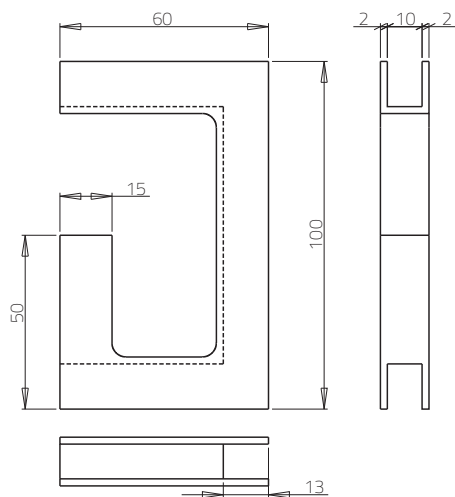

BI53710 Didheya of Spain

code.	A	
BI5370A	10	1
BI5370B	Custom Size	

STAINLESS STEEL AISI 304

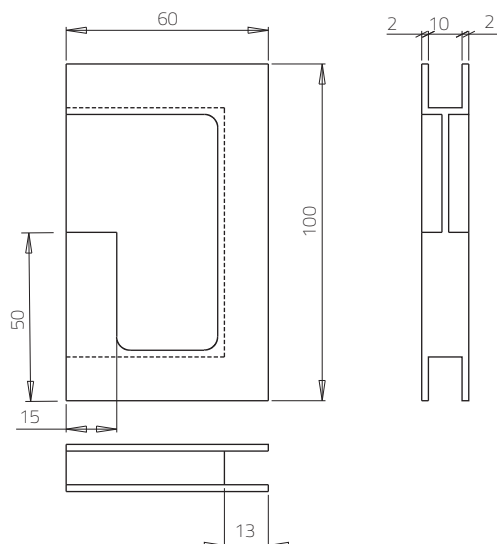
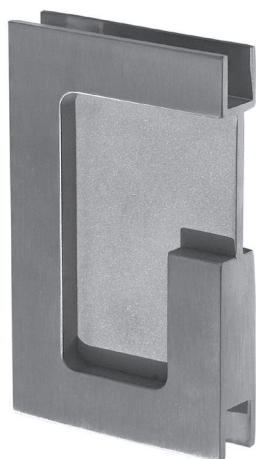

BI53711 Didheya of Spain

code.	A	
BI5371A	10	1
BI5371B	Custom Size	

STAINLESS STEEL AISI 304

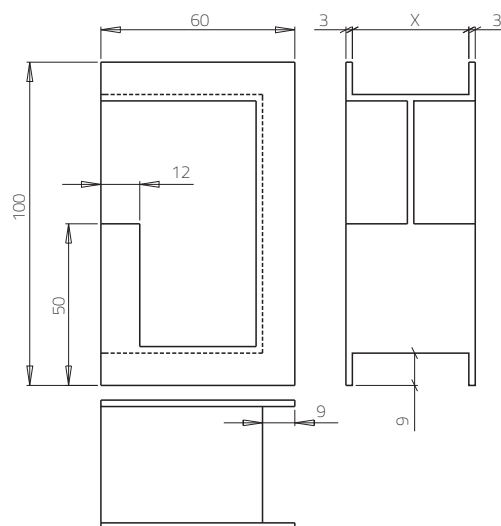

BI53712 Didheya of Spain

code.	x	
BI4253A	35	1
BI4253B	38	1
BI4253C	40	1
BI4253D	43	1
BI4253E	Custom Size	

STAINLESS STEEL AISI 304

Concealed Flush Pull Range

Designed by No-Ha of Belgium
made by Bonaiti of Italy



BINS | Concealed Flush Pull Range

Designed for sliding doors that fully recess into pockets

The BINS range of concealed sliding door flush pulls have been specifically designed to provide a clean smooth contemporary look that is not interrupted by the visual appearance of traditional flush pulls or handles. Unlike traditional sliding door hardware, the BINS range sits flush with the face of the door; as a result the door will fully recess into the sliding door cavity.

Using the BINS range, the formal architectural composition of a door can now continue without interruption of a noticeable handle, creating an aesthetically minimalistic truly clean door.

More and more, tolerance in cavity sliders are becoming smaller & smaller, you can achieve a flawless blend by using the veneer of the door and adhering it to the rectangular push plate. This allows the flush pull to disappear into the door providing you with a beautifully clean solid door face.

The BINS range's beautiful contemporary look is achieved without compromising the functionality of the flush pull. The cavity, created when pressing the faceplate in, ranges from a minimum of 32mm through to 43mm deep based on door thickness, providing ample room from either side of the door.

An additional benefit of the BINS clever design; you can grab the flush pull from any side or position of its rectangular shape. This feature is due to the unit using four (4) springs, not a mechanism when pressing the face plate in.



BINS | Concealed Flush Pull Range - Technical Data

Designed for sliding doors that fully recess into pockets

Designed by No-Ha of Belgium and made 100% in Europe by Bonaiti of Italy, the BINS range of concealed flush pulls are made from industrial strength nylon and steel. The BINS range has shown to be a real winner in terms of reliability, functionality and aesthetic appeal.

Suitable for doors from 38mm to 50mm thick for double sided, 27 - 38mm for single sided; installation of the BINS range is achieved via use of a custom 44mm milling tool, by routing a hole in the door specifically sized for the units to drop in. There is no need for the door to be pulled apart, or to remove the face of the door. Using the BIZ44 milling tool (*available for purchase or rental*) fitting can be completed on site or in the factory.

With the added benefit of four independent steel springs fixed to the underside of each push plate, you can rest easy knowing it will always bounce back and sit flush with the face of the door.

The BINS range comes with a 2-year manufacturer's guarantee.

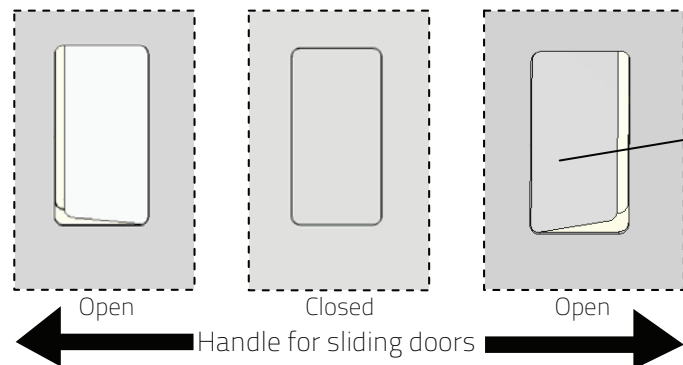
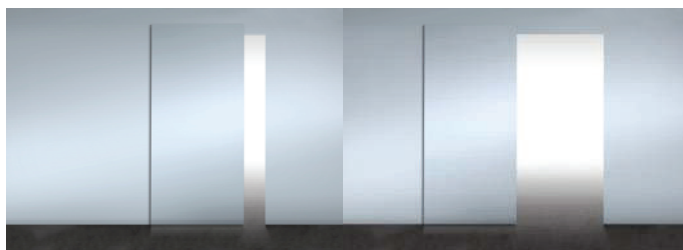

Back to Back Flush Pulls for Sliding Doors

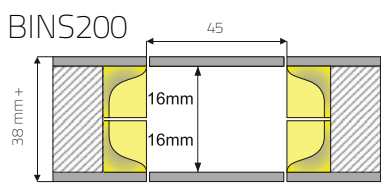

38 to 42mm thick doors

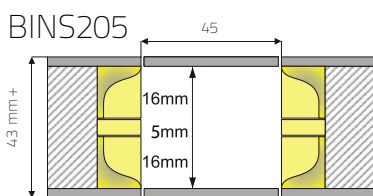

43 to 47mm thick doors

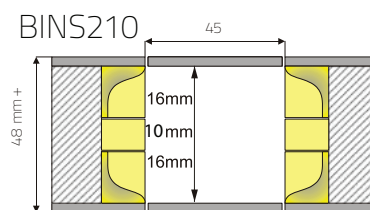

48 to 50mm thick doors

Single Side Only Flush Pull for Sliding Doors

BINS105

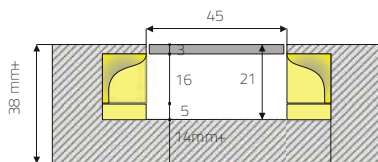
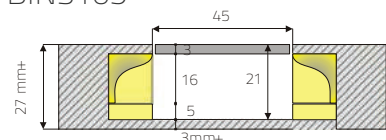

Measurements:

- Opening: 87mm x 45mm
- Cover plate: 85.5mm x 43.5mm
- Note: The MDF or other material cover plate is made to match the surface finish of the door and is adhered to the face plate of BINS range mechanism. (purchased separately)

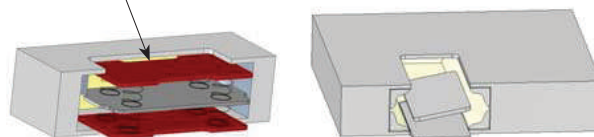

Order Codes:

- BINS200 - For doors 38 - 42mm thick
- BINS205 - For doors 43 - 47mm thick
- BINS210 - For doors 48 - 50mm thick
- BINS105 - Single Side only 27mm +
- BIZ44B - Milling Tool (Buy)
- BIZ44R - Milling Tool (Rent)
- BINKPM - MDF Pre-Cut Cover Plate
- BINKPA - Aluminium Pre-Cut Cover Plate
- BINKPS - Stainless Steel Pre-Cut Cover Plate
- BINKPB - Bronze Pre-Cut Cover Plate

BINK250 | Single Sided Concealed Flush Pull

Designed as a invisible pull for cupboards and drawers fronts

The BINK250 concealed cupboard and drawer pull has been specifically designed to provide a clean, smooth contemporary look that is not interrupted by the visual appearance of traditional cabinet pulls or handles. Unlike traditional handles the BINK250 sits flush with the face of the cupboard and drawer, creating an aesthetically appealing appearance that is truly clean and elegant.

By using the veneer of the door or other material, and adhering it to the rectangular push plate you can achieve a fully blended pull that looks and acts as part of the cupboard or drawer. The BINK250 provides you with a beautifully clean solid cupboard and drawer face. Designed to be used in a horizontal or vertical position, the BINK250 is suitable for almost any opening and closing application.

The BINK250's beautiful contemporary look is achieved without compromising the functionality of the pull. The cavity that the BINK250 creates when pressing the faceplate in is 19mm deep, provides ample room for even the largest of hands. An additional benefit of the BINK250's clever design, you can grab the pull from any side or position of its rectangular shape. This feature is due to the unit using four (4) springs, not a single sided mechanism when pressing the faceplate in.

A clean wall - no handles



BINK250 | Single Sided Concealed Flush Pull - Technical Data

Designed for cupboard and drawer fronts

Like its bigger brother (the BINS range), the BINK250 is also designed by No-Ha of Belgium and made 100% in Europe by Bonaiti of Italy, is an ideal solution where you need a single sided flush pull. Made from industrial strength nylon and steel, the BINK250 is also a real winner.

Installation of the BINK250 is achieved via use of a custom 44mm milling tool. It cuts a hole on the inside of the cupboard or drawer specifically sized for the BINK250 to drop in. Using the BIZ44 milling tool (available for purchase or rental) fitting can be completed on site or in the factory.

With the added benefit of four independent steel springs fixed to the underside of the push plate, you can rest easy knowing it will always bounce back and sit flush with the face of the door.

The BINK250 comes with a 2-year manufacturer's guarantee.

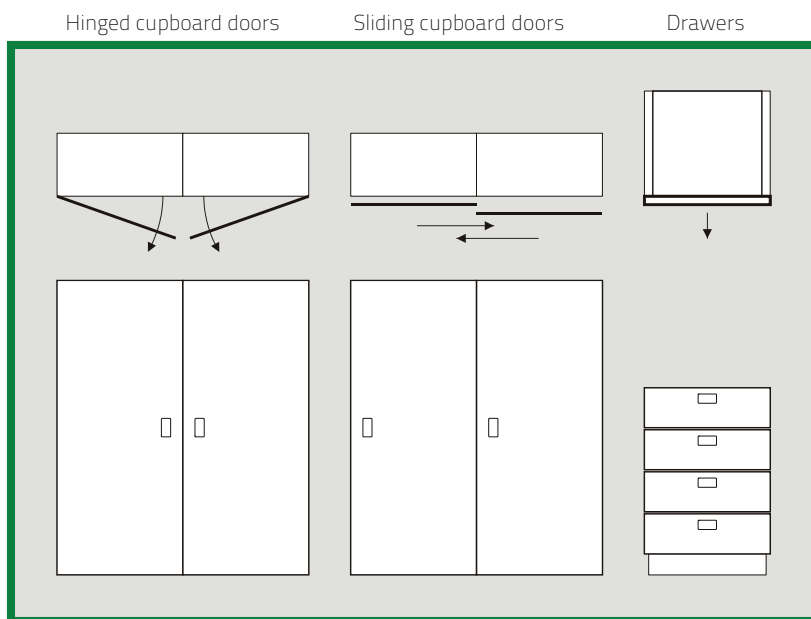

BINK 250



Measurements :

- Opening: 87 mm x 45 mm
- Cover plate: 85.5 mm x 43.5 mm
- Note: The MDF or other material cover plate is made to match the surface finish of the cupboard or drawer panel and is adhered to the face plate of the BINK250 mechanism. (purchased separately)

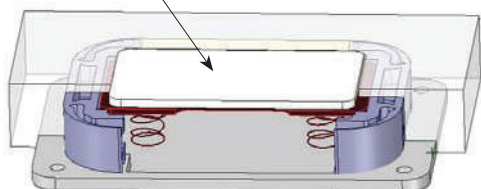

Order Codes:
▪ BINK250 - For doors 19 - 24mm thick
▪ BIZ44B - Milling Tool (Buy)
▪ BIZ44R - Milling Tool (Rent)
▪ BINKPM - MDF Pre-Cut Cover Plate
▪ BINKPA - Aluminium Pre-Cut Cover Plate
▪ BINKPS - Stainless Steel Pre-Cut Cover Plate
▪ BINKPB - Bronze Pre-Cut Cover Plate

BIZ44 | Milling Tool - Technical Data

Designed for the BL004 & BL005, BINS & BINK range of concealed flush pulls

No longer is it a costly, difficult and time consuming process to fit-off rebated hardware. Not when you have the correct tool for the job.

Specifically made for the installation of the No-Ha invisible range of products, the BIZ44 milling tool makes the installation process a breeze. No more chiselling or chipping the timber; the BIZ44 is specific to the requirement.

The BIZ44 cuts a hole in the timber door and/or face of the cupboard or drawer specifically sized for the BINS200 and BINK250 to drop in. Using the BIZ44 milling tool (available for purchase or rental) fitting can be completed on site or in the factory.

With the added benefit of four independent cutting edges, the BIZ44 has been made with multiple uses in mind.

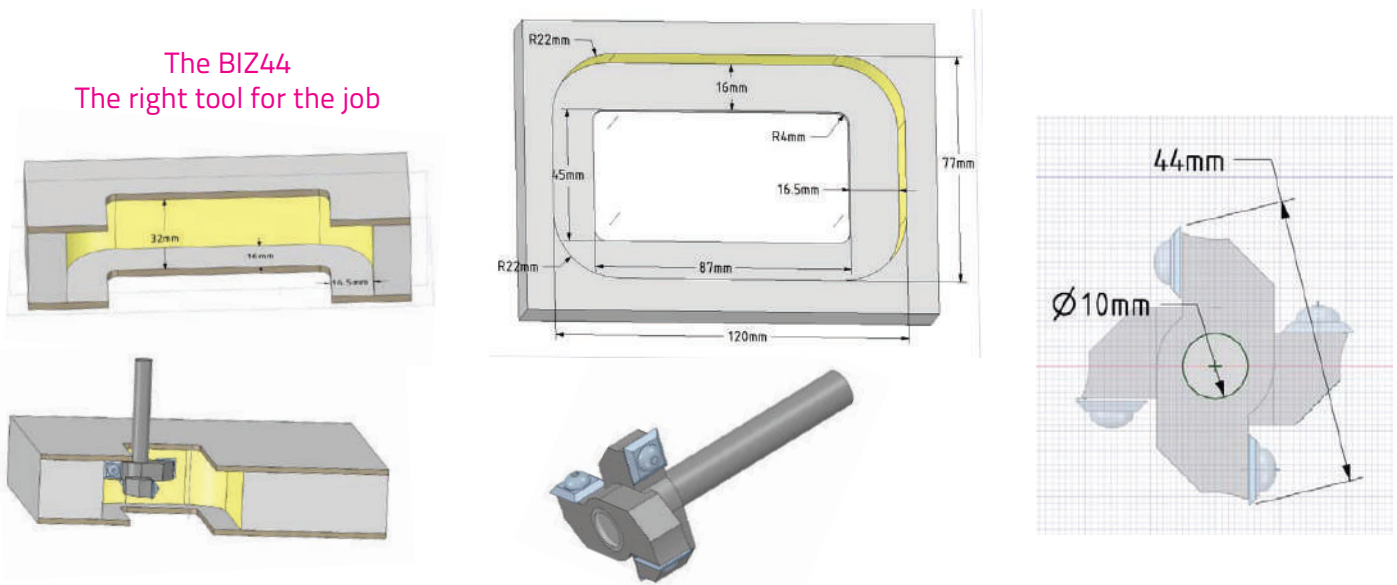

The BIZ44
The right tool for the job

Used throughout Europe to achieve a blended look, the No-Ha range of concealed handles meets today's minimalistic look and feel of modern architecture and Interior design.

Now being used in residential and commercial projects throughout Australia and New Zealand.



Used On:

- Swing Doors
- Sliding Doors
- Drawers
- Cupboards



Practical Application:

- Desks
- Kitchens
- Furniture
- WC doors
- Utility rooms
- Pantry doors
- Hidden rooms
- Cupboard Drawers
- Bathroom entry doors
- Doors in narrow hallways

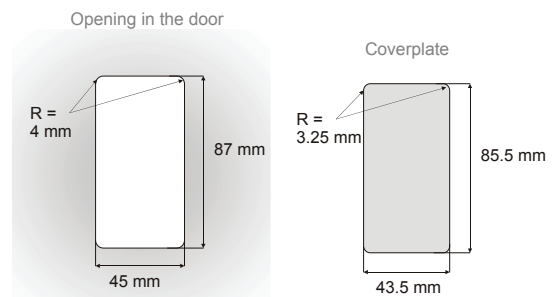
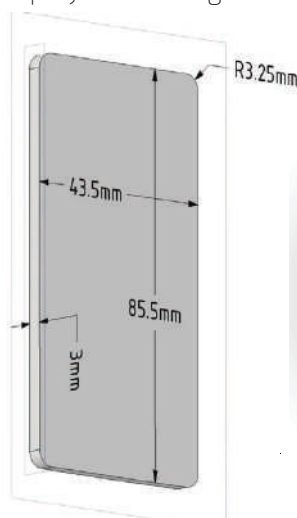

Cover Plate Dimensions

Order Codes:

- BIZ44B - Milling Tool (Buy)
- BIZ44R - Milling Tool (Rent)
- BINKPM - MDF Pre-Cut Cover Plate
- BINKPA - Aluminium Pre-Cut Cover Plate
- BINKPS - Stainless Steel Pre-Cut Cover Plate
- BINKPB - Bronze Pre-Cut Cover Plate

Sly: Flush pulls by Didheya of Spain



Six millimeters thick and in multiple designs. The Sly range from Didheya of Spain is innovative, simple, practical and easy to install. Designed for sliding timber or glass doors in constant use, the Sly range is clean and visually different and appealing.

This is a clear example of pragmatism resolved in a six millimeter thick element.

Didheya of Spain by Bellevue

BI4040 Didheya of Spain

Code	H	A	Proj
BI3030A	300	185.41	6
BI3030B	150	92.71	6
BI3030C	85	50	6

Satin Stainless AISI 304

Sold in sets, dimensions in mm, on glass UV glue is recommended. Custom sizes available



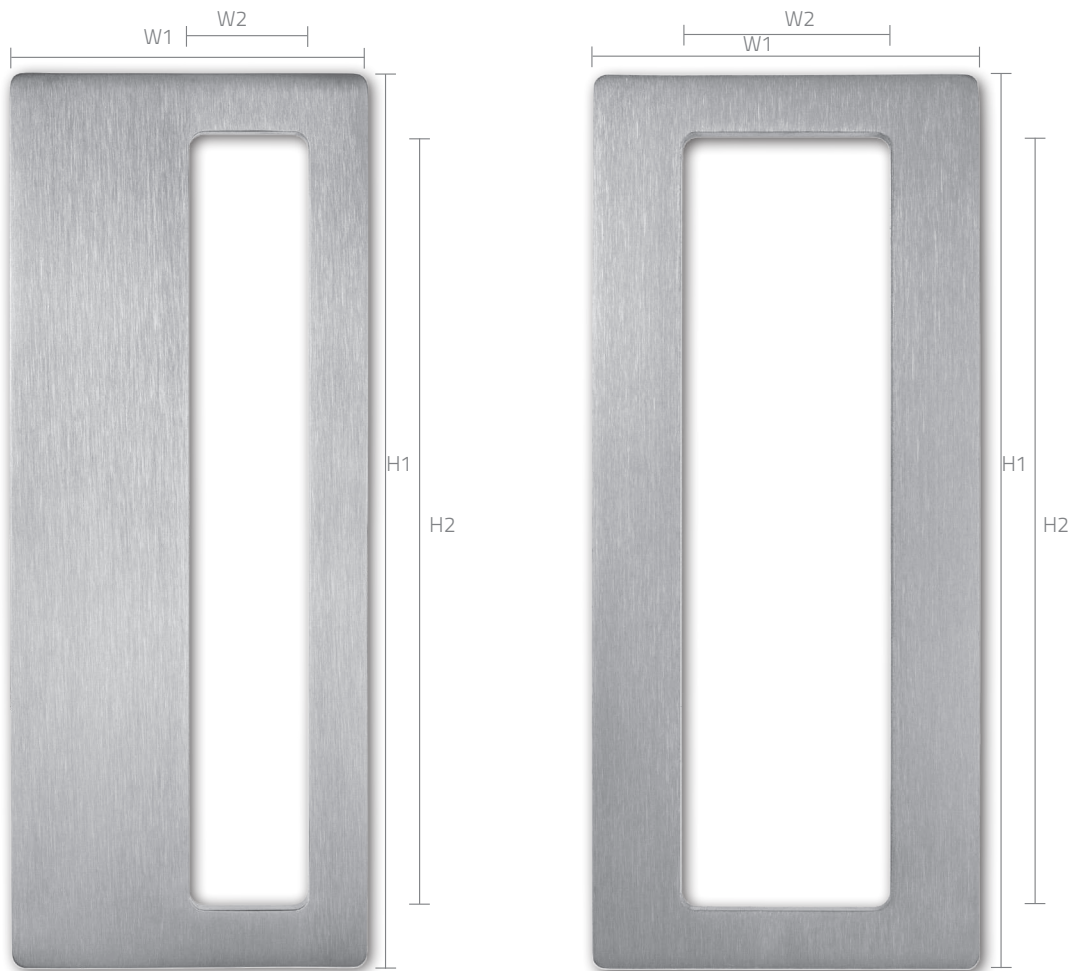

BI4030
Didheya of Spain

Code	H1	H2	W1	W2	Proj
BI4030A	500	480	90	20	6
BI4030B	300	280	75	20	6
BI4030C	150	130	60	20	6

BI4020
Didheya of Spain

Code	H1	H2	W1	W2	Proj
BI4020A	300	280	80	50	6
BI4020B	150	130	65	35	6
BI4020C	85	65	50	20	6

Satin Stainless AISI 304

Sold in sets, dimensions in mm, on glass UV glue is recommended. Custom sizes available



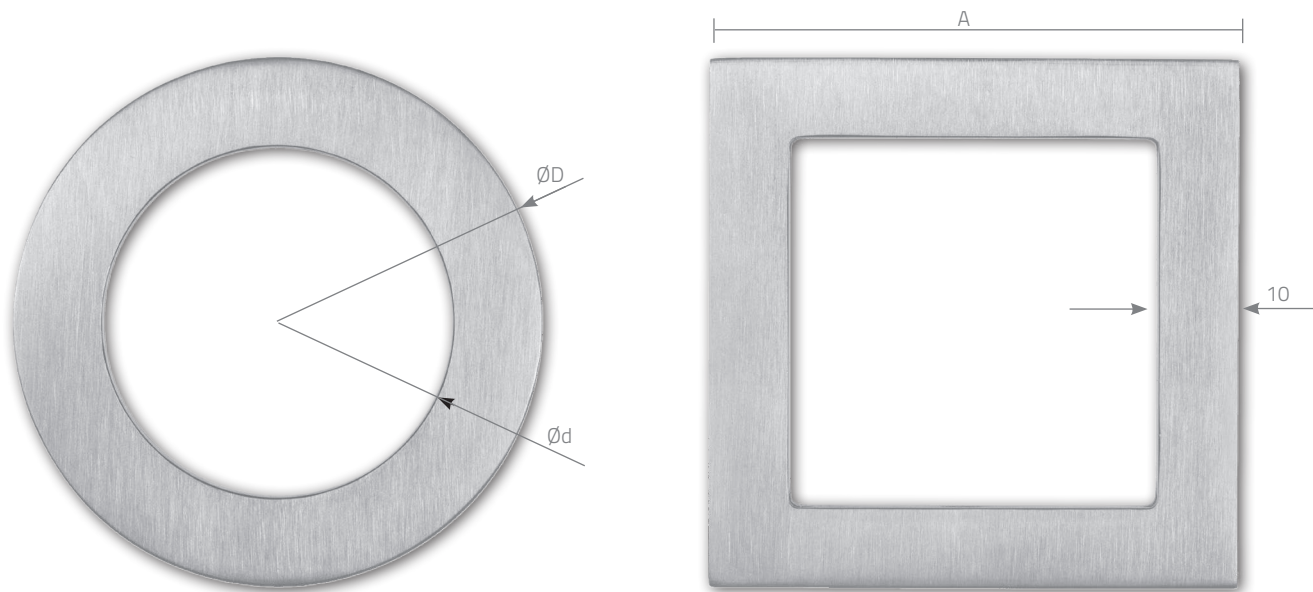

BI3010
Didheya of Spain

Code	ØD	Ød	Proj
BI3030A	100	68	6
BI3030B	70	46	6
BI3030C	40	24	6

BI4010
Didheya of Spain

Code	ØD	Proj
BI3030A	85	6
BI3030B	65	6
BI3030C	50	6

Satin Stainless AISI 304
Sold in sets, dimensions in mm, on glass UV glue is recommended. Custom sizes available



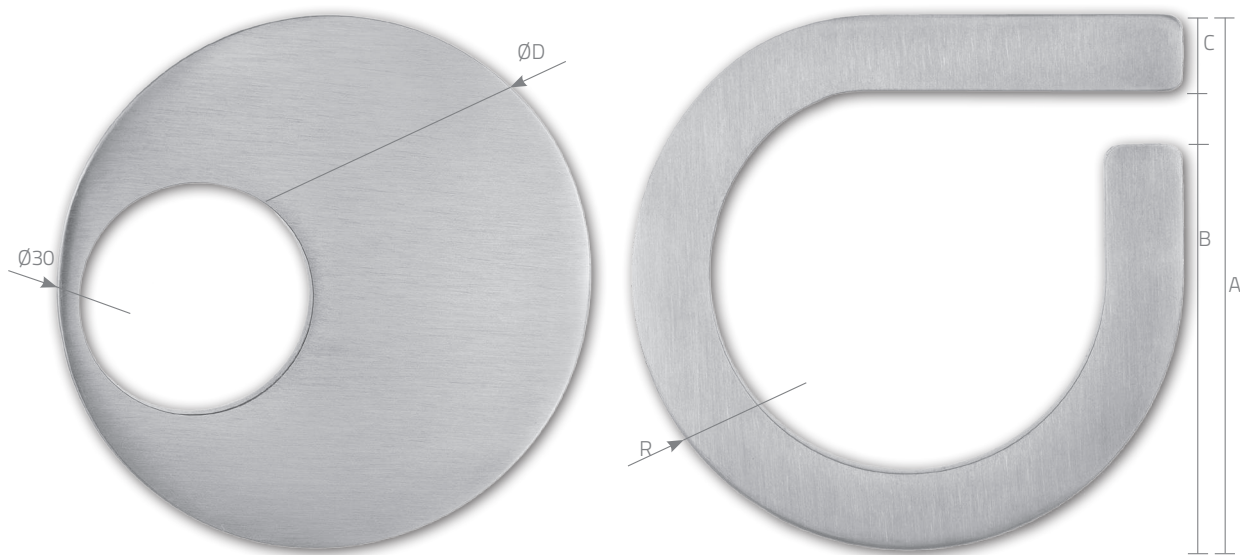

BI3030
Didheya of Spain

Code	$\varnothing D$	Proj
BI3030A	100	6
BI3030B	70	6
BI3030C	40	6

BI3040
Didheya of Spain

Code	A	B	C	R	Proj
BI3040A	100	87.50	12	50	6
BI3040B	70	60	10	35	6
BI3040C	40	30	8	20	6

Satin Stainless AISI 304
Sold in sets, dimensions in mm, on glass UV glue is recommended. Custom sizes available



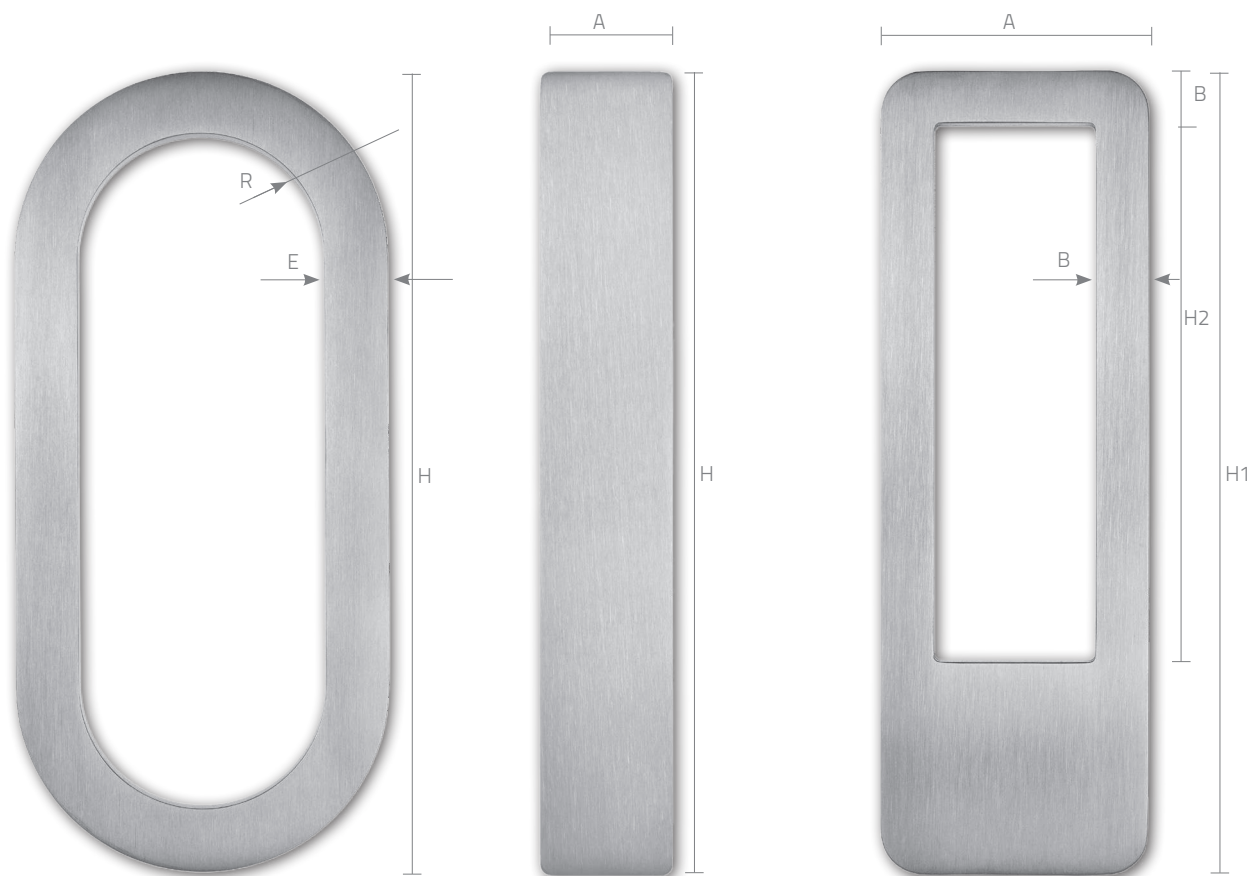

BI3020

Didheya of Spain

Code	R	H	E	Proj
BI3020A	50	300	16	6
BI3020B	35	150	12	6
BI3020C	20	85	8	6

BI4050

Didheya of Spain

Code	H	A	Proj
BI4050A	300	30	6
BI4050B	150	25	6
BI4050C	85	20	6

BI4060

Didheya of Spain

Code	H1	H2	A	B	Proj
BI4060A	300	225	90	15	6
BI4060B	150	100	50	10	6
BI4060C	85	59	35	6	6

Satin Stainless AISI 304

Sold in sets, dimensions in mm, on glass UV glue is recommended. Custom sizes available

B136 | Cubo Floor Mounted Door Stop

Olivari of Italy

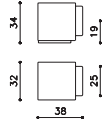

Olivari Cubo - B136M
Magnetic Door Stop

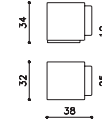

Olivari Cubo - B136N
Non Magnetic Open Door Stop

Available Finishes:
CR, SC
IB, IS, IBN, ISN, ISB
IA, ISC, ISBRZ
PBU, EMB, BRZ, PC

B106 | Victor Floor Mounted Door Stop

Olivari of Italy

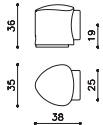

Olivari Victor - B106M
Magnetic Door Stop

Available Finishes:
CR, SC
IB, IS, IBN, ISN, ISB
IA, ISC, ISBRZ
PBU, EMB, BRZ, PC

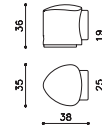

Olivari Victor - B106N
Non Magnetic Door Stop

Available Finishes:
CR, SC
IB, IS, IBN, ISN, ISB
IA, ISC, ISBRZ
PBU, EMB, BRZ, PC

Floor Mounted Door Stops

Olivari of Italy



Olivari Gardena - B103



Available Finishes:
IB
PBU, EMB, BRZ, PC



Olivari Sector - B101



Available Finishes:
CR, SC
IB, IS, IBN, ISN, ISB
ISC, ISBRZ
PBU, EMB, BRZ, PC



Olivari Raffaella - B102



Available Finishes:
CR, SC
IB, IS, IBN, ISN, ISB
IA, ISC, ISBRZ
PBU, EMB, BRZ, PC

Floor Mounted Door Stop

Olivari of Italy



Olivari Stilo - B121



Available Finishes:
CR, SC
IB
PBU, EMB, BRZ, PC

Wall Mounted Door Stop

Olivari of Italy



Olivari Stilo - B123R

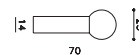

Available Finishes:
CR, SC
IB
PBU, EMB, BRZ, PC

Elmes of Japan - UT400BL

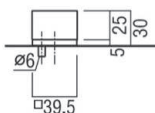

BL = Silver / Black

Confalonieri - 70136



CR - Chrome
SC - Satin Chrome

Confalonieri - 70135



CR - Chrome
SC - Satin Chrome

Half Moon - 60130



CR - Chrome
SC - Satin Chrome
PB - Polished Brass
SN - Satin Nickel
PC - Powder Coat

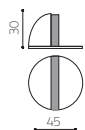

Elmes of Japan - UT260BL



BL = Aluminum / Black

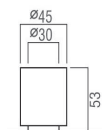

Elmes of Japan - UT300



IV = Ivory
BL = Black

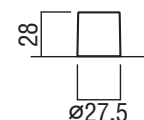

Didheya - 91222



CR - Chrome
SC - Satin Chrome
PC - Powder Coat



Didheya - KU80ASS and KU80BSS



SS - Stainless Steel
PC - Powder Coat

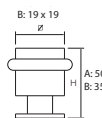

Didheya - KU20SS and KU35SS



SS - Stainless Steel
PC - Powder Coat

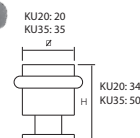

Elmes of Japan - UT270

CR = Chrome / Black
SN = Satin Nickel / Black



CR = Chrome / Black
SN = Satin Nickel / Black

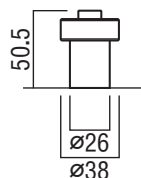

Elmes of Japan - UT271



CR = Chrome / Black
SN = Satin Nickel / Black

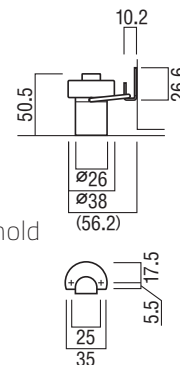

Elmes of Japan - UT261BL



BL = SAA / Black

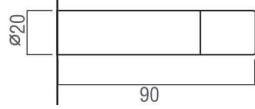

Bullet - B13002



PSS - Polished Stainless Steel
SSS - Satin Stainless Steel
PC - Powder Coat Colours

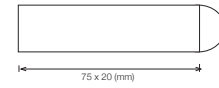

Didheya of Spain - KU50 & KU40

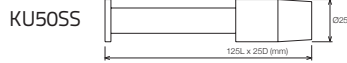

SSS - Satin Stainless Steel
PC - Powder Coat

Square - B3711



PSS - Polished Stainless Steel
SSS - Satin Stainless Steel
PC - Powder Coat

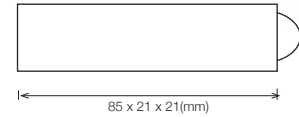

Concealed Door Stops

Elmes of Japan - UT34SSRH | UT34SSLH

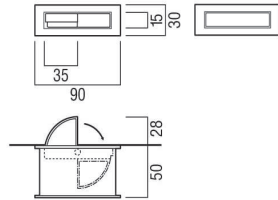

SS = Satin Stainless Steel

Elmes of Japan - UT64

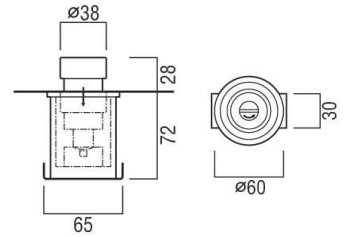

Dull Chrome with Grey Resin

Monster Door Stops for Monster Doors

Elmes of Japan - UT100YBL

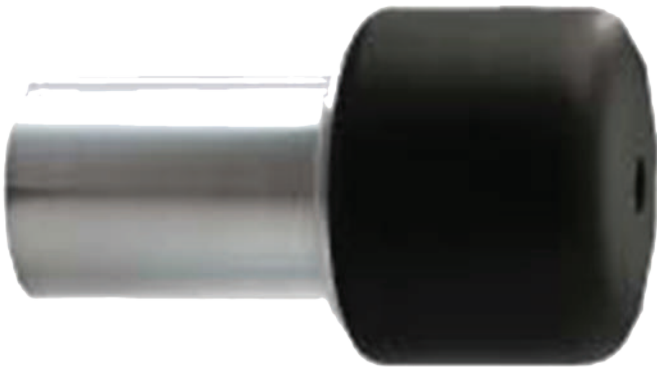

BL = Stainless Steel / Black
PC - Powder Coat

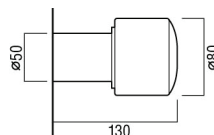

Elmes of Japan - UT100BL



BL = Stainless Steel / Black
PC - Powder Coat

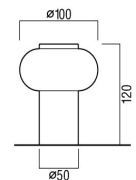





G2401

Base Material
Aluminium

Available Finish
Blast Anodised Silver & Anodised Silver (S)
Blast Anodised Black & Anodised Black (B)

Available Sizes (mm)
Length 455, Centres 425

Fixing Holes Sizes
Door 10mm, Glass 16mm

Specification Code
G2401 - 455 - finish

Bellevue Architectural
954 Glenhuntly Road, Caulfield South, Victoria, 3162

Ph: +61 3 9571 5666
Fax: +61 3 9571 1347

www.bellevuearch.com.au
info@bellevuearch.com.au

*Please note that all images in this document are used for illustrative purposes only.

Bellevue Imports Pty Ltd trading as Bellevue Architectural
Flush & Sliding Pulls: Catalogue AU 11/19